

DESPIECE

CONJUNTO CHASIS

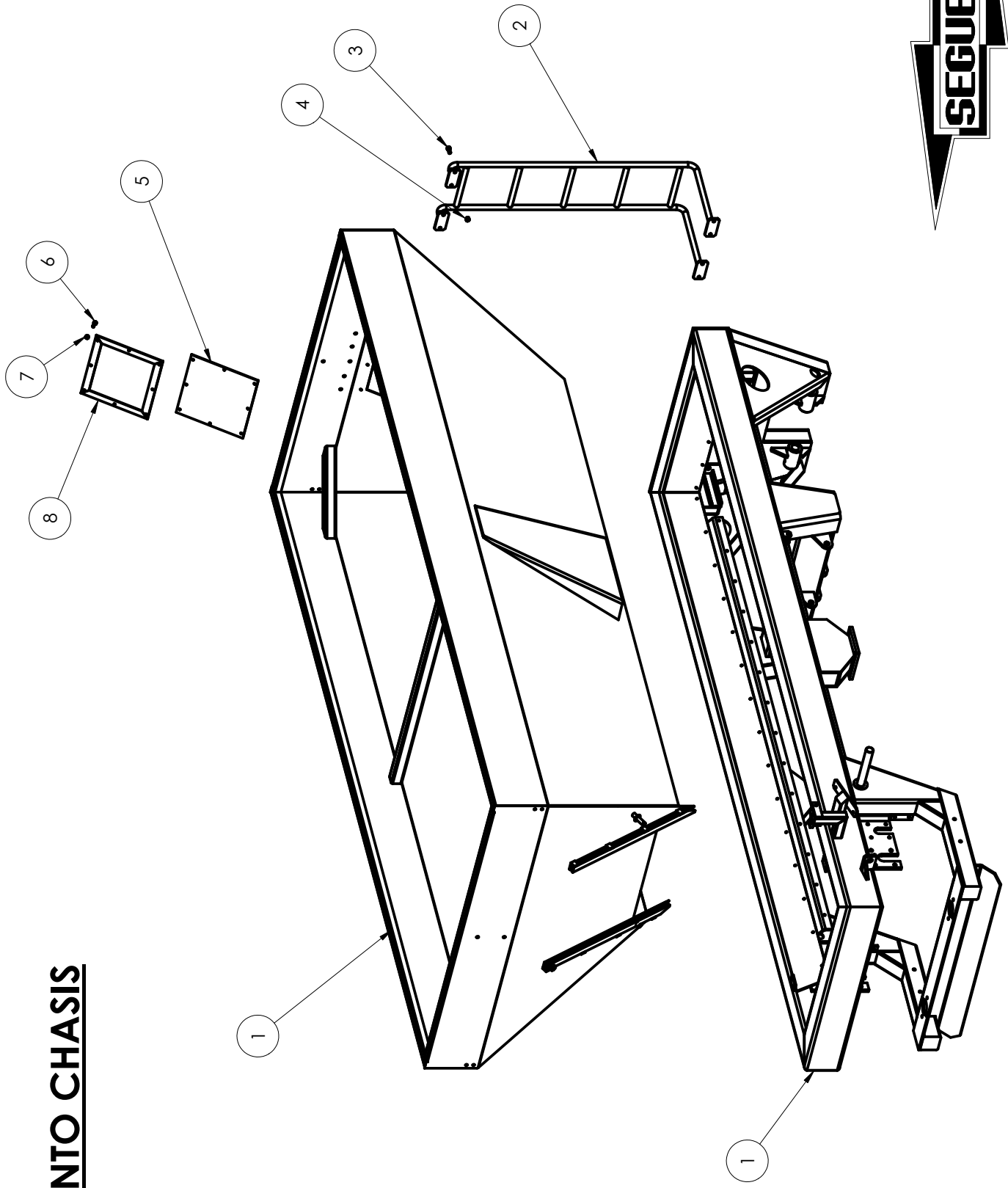

ABONADORA DE CINTA 10.000 KG.

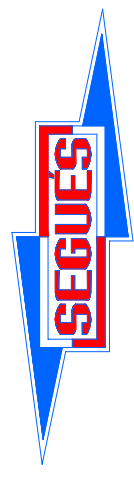

CONJUNTO CHASIS

N° PIEZA	CODIGO	DENOMINACION	UNID	N° PIEZA	CODIGO	DENOMINACION	UNID
1	00100100	CONJUNTO CHASIS ABONADORA 10.000 Kg	1				
2	00105100	CONJUNTO ESCALERA	1				
3	---	TORNILLO HEXAGONAL M-12 x 30	8				
4	---	TUERCA M-12	8				
5	00107200	PLANCHA REGISTRO	1				
6	---	TORNILLO HEXAGONAL M-10 x 30	8				
7	---	TUERCA M-10	8				
8	00107100	MARCO SOPORTE REGISTRO	1				

SISTEMA CIERRE TOLVA

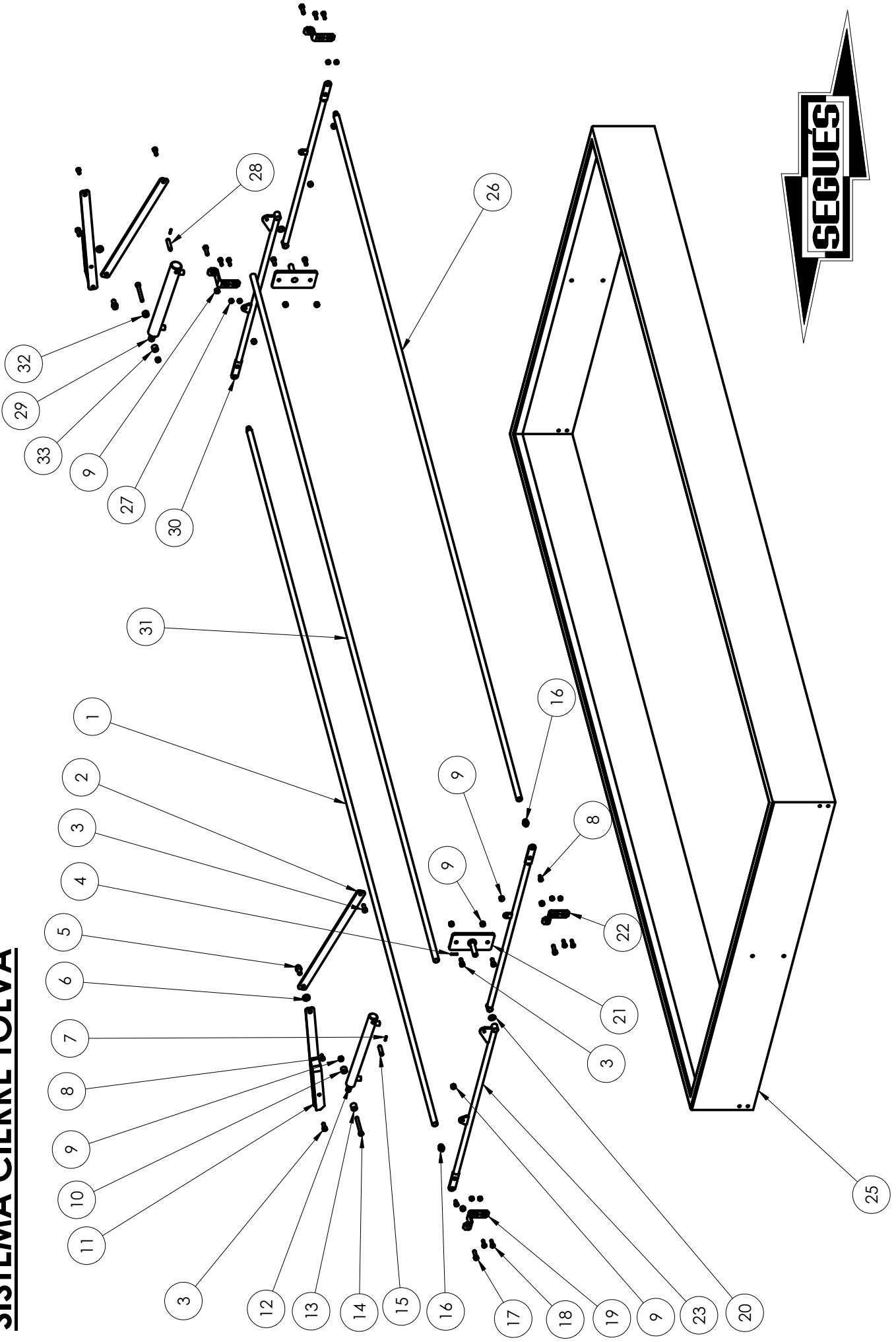

ABONADORA DE CINTA 10.000 KG.

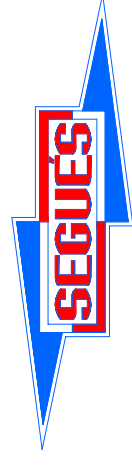

SISTEMA CIERRE TOLVA

N° PIEZA	CODIGO	DENOMINACION	UNID	N° PIEZA	CODIGO	DENOMINACION	UNID
1	00105500	BARRA SOPORTE LONA CIERRE TOLVA	1	18	---	TORNILLO HEXAGONAL M10 x 30	8
2	00105800	PLETINA BRAZO TIJERA CIERRE TOLVA	2	19	00106700	PLETINA FIJACION CIERRE TOLVA	2
3	---	TORNILLO HEXAGONAL M-12 x 30	8	20	00106300	ARANDELA SUPLEMENTO	2
4	---	PASADOR ELASTICO M-6 x 30	2	21	00105300	SOPORTE PIVOTAJE CIERRE TOLVA	2
5	00106002	MECHA FIJACION	2	22	00106600	PLETINA FIJACION CIERRE TOLVA	2
6	00105900	CASQUILLO SUPLEMENTO	2	23	00105600	BRAZO CIERRE TOLVA	1
7	---	PASADOR M-5 x 24	2	24	00105400	BRAZO CIERRE TOLVA	2
8	---	TORNILLO HEXAGONAL M-10 x 20	6	25	---	TOLVA ABONADORA	1
9	---	TUERCA M-12	14	26	00106101	BARRA SOPORTE LONA CIERRE TOLVA	1
10	00106500	CASQUILLO SUPLEMENTO	1	27	---	TUERCA M-10	8
11	00105700	BRAZO TIJERA CIERRE TOLVA	2	28	00107606	EJE SUJECCION PISTON	1
12	00106200	PISTON CIERRE TOLVA	1	29	00107500	PISTON CIERRE TOLVA	2
13	00106400	CASQUILLO SUPLEMENTO	1	30	00107600	BRAZO CIERRE TOLVA	1
14	---	TORNILLO HEXAGONAL M-12 x 100	2	31	00106001	BARRA SOPORTE LONA CIERRE TOLVA	1
15	00105606	EJE SUJECCION PISTON	1	32	00107700	CASQUILLO SUPLEMENTO	1
16	00105502	MECHA FIJACION	4	33	00107800	CASQUILLO SUPLEMENTO	1
17	---	TORNILLO HEXAGONAL M-12 x 40	4	34			

CONJUNTO EJE Y LANZA

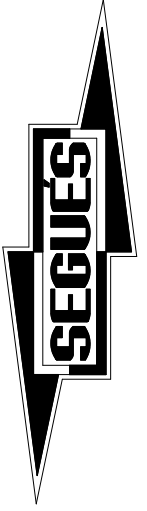
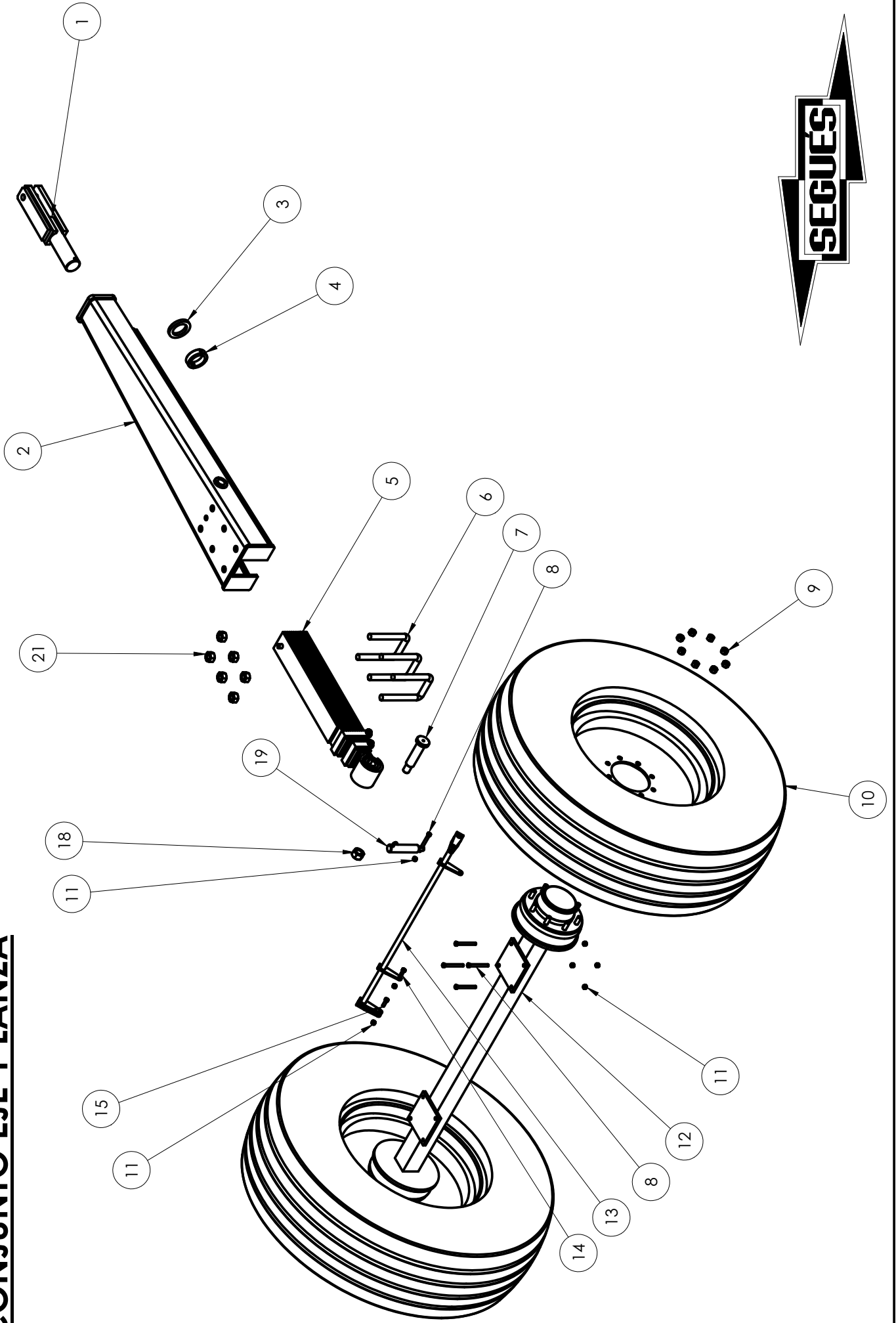

ABONADORA DE CINTA 10.000 KG.



CONJUNTO EJE Y LANZA

Nº PIEZA	CODIGO	DENOMINACION	UNID	Nº PIEZA	CODIGO	DENOMINACION	UNID
1	00102400	CONJUNTO ENGANCHE	1	18	---	TUERCA M-33	1
2	00102300	CONJUNTO LANZA	1	19	00107400	PISTON FRENO	1
3	00102500	ARANDELA SUPLEMENTO ENGANCHE	1	20	---	SIRGA DE FRENO	1
4	00106800	CASQUILLO FIJACION ENGANCHE	1	21	---	TUERCA M-30	6
5	---	GEPLASMETAL B-120x14/11 DT	1				
6	---	ABARCON M-30 x 151 x 245	3				
7	00103400	BULON ENGANCHE LANZA	1				
8	---	TORNILLO HEXAGONAL M-12 x 60	9				
9	---	TUERCA M-20	16				
10	---	RUEDA 18.4/15-34 P.R.14	2				
11	---	TUERCA M-12	13				
12	00102100	CONJUNTO EJE	1				
13	00107300	CONJUNTO EJE FRENO HIDRAULICO	1				
14	---	TORNILLO HEXAGONAL M-12 x 25	2				
15	---	TORNILLO HEXAGONAL M-12 x 40	2				
16	---	FRENO DE MANO	1				
17	---	SIRGA DE FRENO	1				

SISTEMA AVANCE CINTA DE ARRASTRE

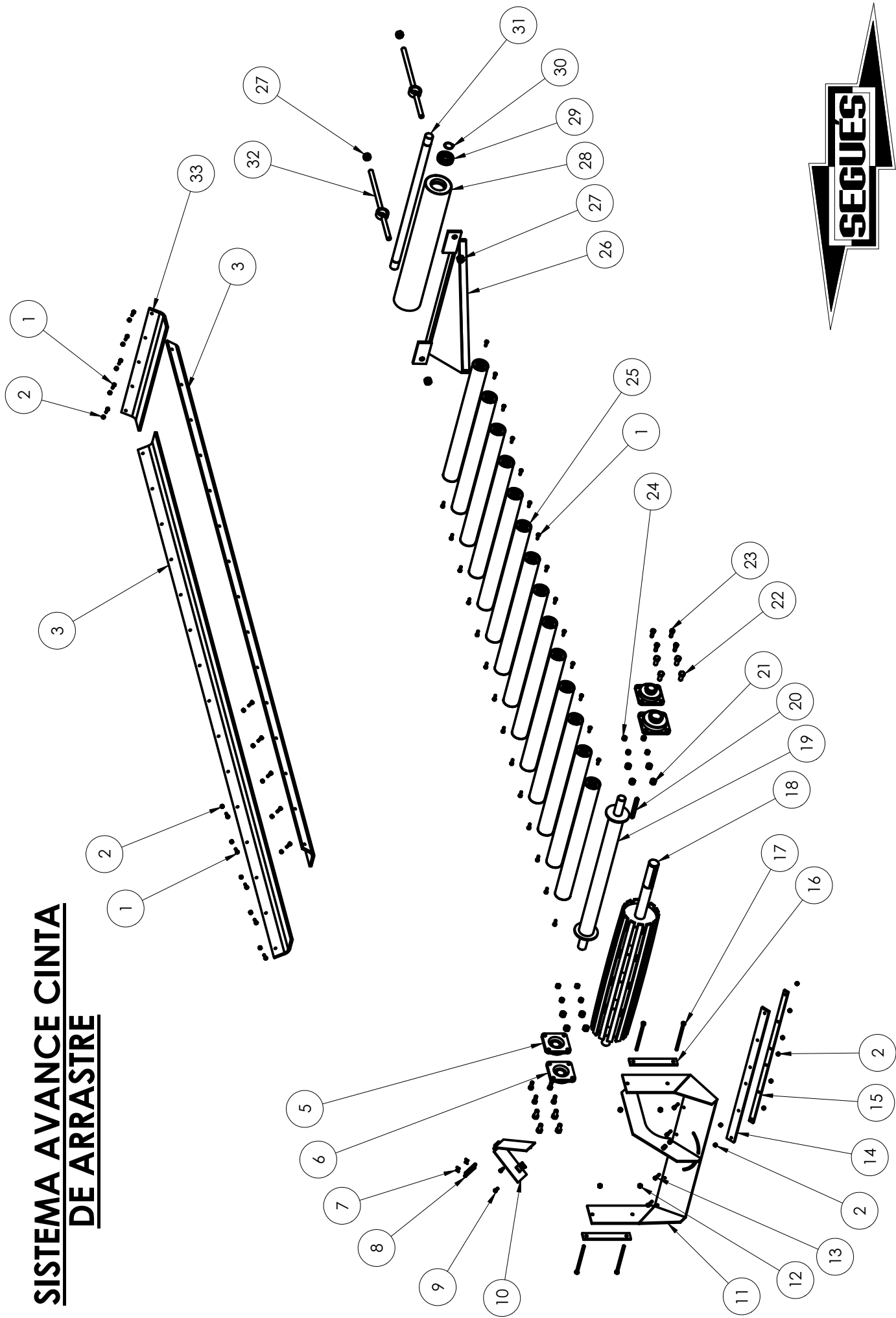

ABONADORA DE CINTA 10.000 KG.

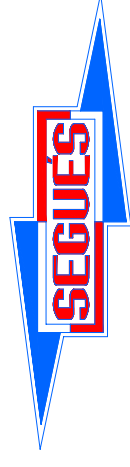

SISTEMA AVANCE CINTA DE ARRASTRE

Nº PIEZA	CODIGO	DENOMINACION	UNID	Nº PIEZA	CODIGO	DENOMINACION	UNID
1	---	Tornillo hexagonal M-8 x 25	63	18	00100200	Rodillo arrastre cinta	1
2	---	Tuerca M-8	43	19	00100300	Rodillo apoyo posterior	1
3	00103600	Lona rascador	2	20	---	Chaveta 14 x 9 x 140	1
4	---	Cinta arrastre	1	21	---	Tuerca M-16	8
5	---	Rodamiento INA PCJ 40	2	22	---	Tornillo hexagonal M-16 x 35	8
6	---	Rodamiento INA PCJ 40	2	23	---	Tornillo hexagonal M-12 x 35	8
7	---	Pasador elastico	4	24	---	Tuerca M-12	8
8	00104200	Eje articulacion pala	2	25	00100800	Rodillo intermedio	14
9	---	Tornillo hexagonal M-8 x 20	2	26	00100900	Racador delantero	1
10	00104100	Pala distribuidora abono	2	27	---	Tuerca M-20	4
11	00103900	Distribuidor salida abono	1	28	00100500	Rodillo delantero	1
12	---	Tuerca hexagonal M-10	4	29	---	Rodamiento 6208	2
13	---	Tornillo hexagonal M-8 x 35	6	30	---	Seger E-40	2
14	00104300	Lona rascador	1	31	00100600	Eje rodillo delantero	1
15	00104400	Pletina sujeccion rascador	1	32	00100700	Tensor rodillo delantero	2
16	00104000	Pletina fijacion distribuidor	2	33	00103700	Lona rascador	1
17	---	Tornillo hexagonal M-10 x 185	4				

SISTEMA AVANCE PROPORCIONAL

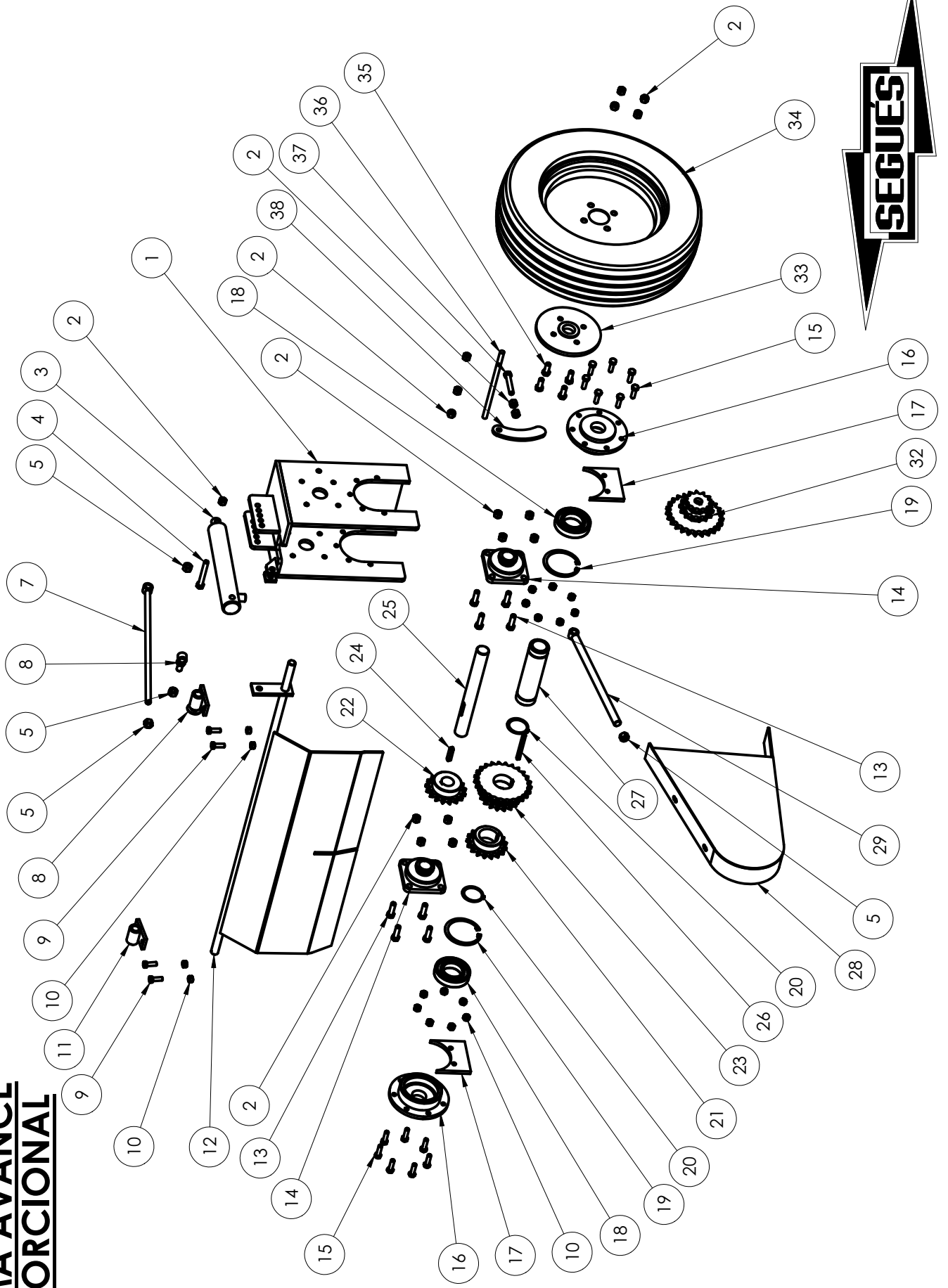

ABONADORA DE CINTA 10.000 KG.

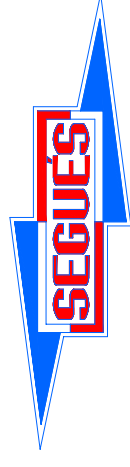

SISTEMA AVANCE PROPORCIONAL

N° PIEZA	CODIGO	DENOMINACION	UNID	N° PIEZA	CODIGO	DENOMINACION	UNID
1	00102700	SOPORTE RUEDA ARRASTRE	1	18	---	RODAMIENTO 6211	2
2	---	TUERCA M-12	18	19	---	SEGER I-100	2
3	00103100	PISTON TENSOR CADENA	1	20	---	SEGER E-55	2
4	---	TORNILLO HEXAGONAL M-12 x 90	1	21	00108000	PIÑON TRANSMISION	1
5	---	TUERCA M-14	4	22	00108100	PIÑON TRACCION	1
6	---	TORNILLO HEXAGONAL M-14 x 60	1	23	00102900	PIÑON CONDUCTOR ARRASTRE CINTA	1
7	00104900	BARILLA TENSORA	1	24	---	CHAVETA 10 x 8 x 50	1
8	00104604	ARANDELA TOPE	1	25	00102800	EJE SOPORTE RUEDA ARRASTRE	1
9	---	TORNILLO HEXAGONAL M-10 x 30	4	26	---	CHAVETA 8 x 7 x 100	1
10	---	TUERCA M-10	18	27	00107900	EJE BASCULACION Y GIRO	1
11	00104800	ENGANCHE BARILLA	2	28	00105000	TAPA CADENA	1
12	00104600	CONJUNTO CIERRE POSTERIOR	1	29	00103200	BARILLA TENSORA	1
13	---	TORNILLO HEXAGONAL M-12 x 40	8	30	---	REDUCTOR CTD-60	1
14	---	RODAMIENTO INA PCJ 35	2	31	---	CHAVETA 6 x 6 x 35	1
15	---	TORNILLO HEXAGONAL M-10 x 35	7	32	00103000	PIÑON CONDUCIDO	1
16	00108200	BUJE EJE BASCULACION Y GIRO	2	33	00102802	ARO SOPORTE RUEDA	1
17	00108300	PLETINA CIERRE	2	34	---	RUEDA AVANCE 155/80R-13"	1

ABONADORA DE CINTA 10.000 KG.

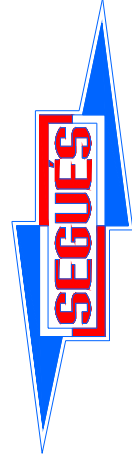

SISTEMA AVANCE PROPORCIONAL

Nº PIEZA	CODIGO	DENOMINACION	UNID	Nº PIEZA	CODIGO	DENOMINACION	UNID
35	---	TORNILLO HEXAGONAL M-12 x 30	4				
36	00108500	ESPARRAGO FIJACION TENSOR	1				
37	---	TORNILLO HEXAGONAL M-12 x 70	1				
38	00108400	BIELA TENSORA	1				

SISTEMA CON PLATOS

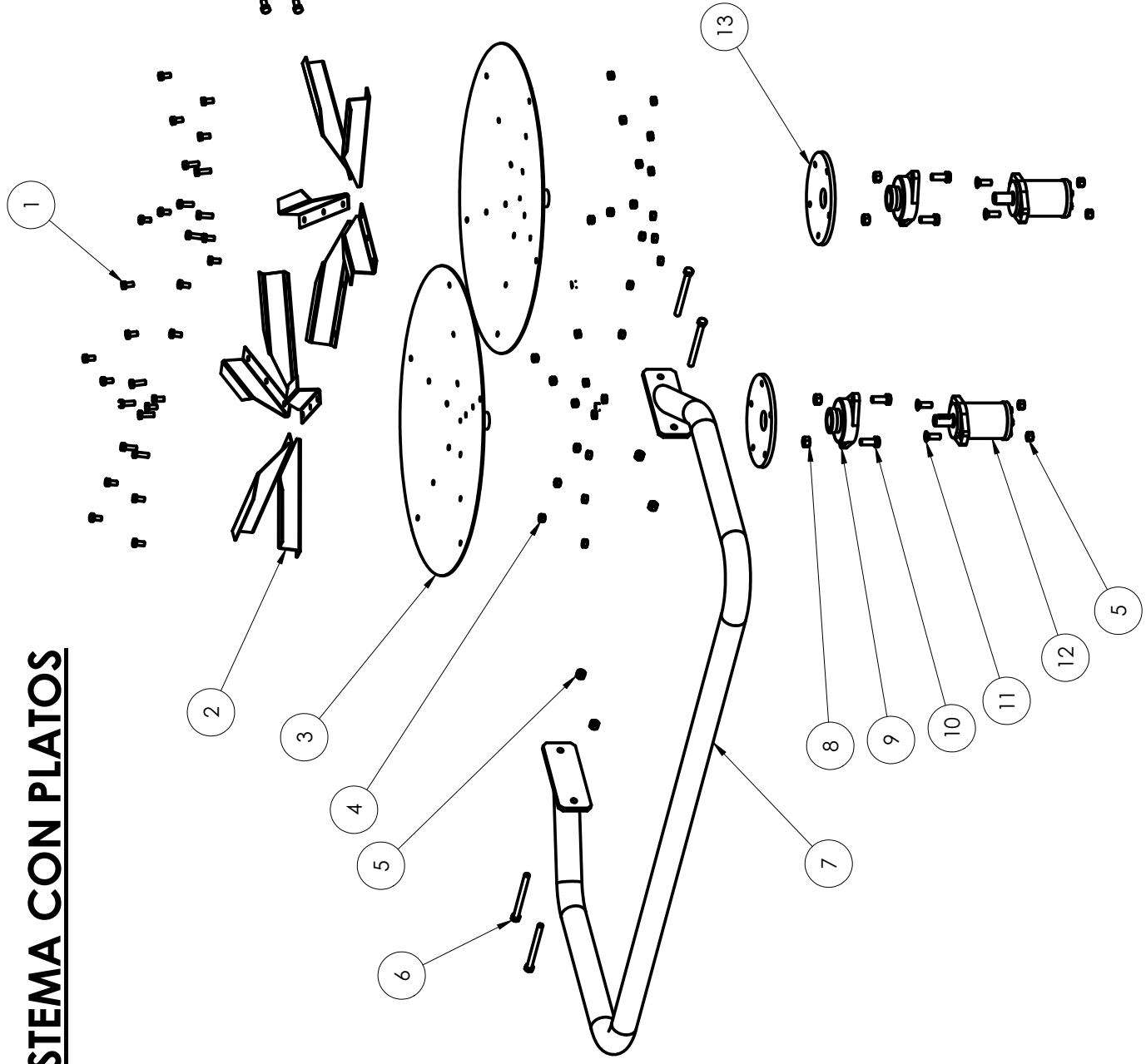

ABONADORA DE CINTA 10.000 KG.

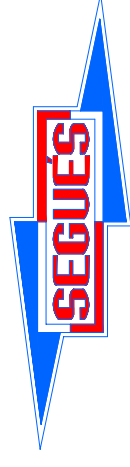

CONJUNTO PLATOS

Nº PIEZA	CODIGO	DENOMINACION	UNID	Nº PIEZA	CODIGO	DENOMINACION	UNID
1	---	Tornillo hexagonal M-10 x 20	30				
2	00101200	Pala esparcidora abono	10				
3	00101100	Disco esparcidor abono	2				
4	---	Tuerca M-10	30				
5	---	Tuerca M-12	10				
6	---	Tornillo M-12 x 140	4				
7	00107000	Conjunto protector discos	1				
8	---	Tuerca M-14	4				
9	---	Rodamiento INA PCJT 40	2				
10	---	Tornillo hexagonal M-14 x 35	4				
11		Tornillo avellanado M-12 x 35	4				
12	---	Motor hidraulico Roquet	2				
13	00101300	Acolplamiento disco	2				
14	---	Tornillo hexagonal M-12 x 35	4				
15	00104500	Plancha protectora salida abono	1				

SISTEMA COMPUERTA
POSTERIOR

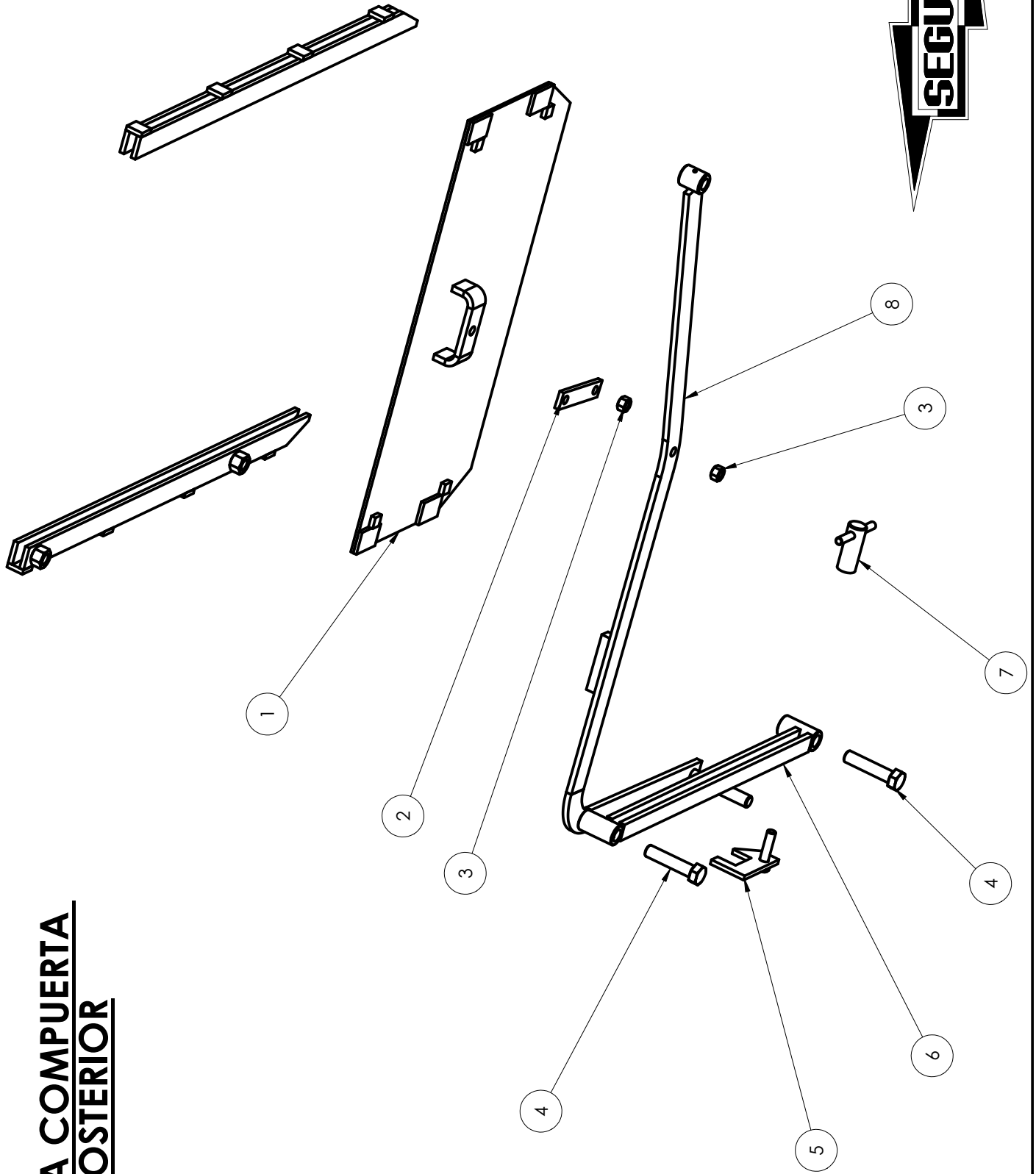

ABONADORA DE CINTA 10.000 KG.

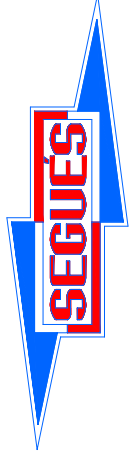

SISTEMA COMPUERTA POSTERIOR

Nº PIEZA	CODIGO	DENOMINACION	UNID.	Nº PIEZA	CODIGO	DENOMINACION	UNID.
1	00101500	COMPUERTA POSTERIOR	1				
2	00101600	BIELA COMPUERTA POSTERIOR	1				
3	---	TUERCA HEXAGONAL M-14	2				
4	---	TORNILLO HEXAGONAL M-20 x 90	2				
5	00101800	FIJACION MANIVELA COMPUERTA	1				
6	00102000	REGLETA REGULACION COMPUERTA	1				
7	00101900	ANCLAJE MANIVELA	1				
8	00101700	MANIVELA COMPUERTA POSTERIOR	1				
9	---	TORNILLO HEXAGONAL M-14 x 35	2				